



# SERIES EG SWITCHES

## SLIDE SWITCHES

TACT. SWITCHES

NAVIGATION SWITCHES

PUSHBUTTON SWITCHES

TOGGLE SWITCHES

ROCKER SWITCHES

SLIDE SWITCHES

SNAP-ACTION SWITCHES

DIP SWITCHES

KEYLOCK SWITCHES

ROTARY SWITCHES

DETECTOR SWITCHES

CAP. OPTIONS



### SPECIFICATIONS

Contact Resistance:	Less than 20 milliohms
Insulation Resistance:	500VDC – 100 milliohms
Dielectric Strength:	500V AC for 1 minute between any terminal and frame
Operating Temperature:	-20°C to +70°C (-4°F to +158°F)

### FEATURES & BENEFITS

- ▶ Variety of package styles & sizes
- ▶ Up to 6 poles
- ▶ Variety of functions
- ▶ Positive detent
- ▶ SMT options

### APPLICATIONS/MARKETS

- ▶ Computer servers/peripherals
- ▶ Consumer electronics
- ▶ Instrumentation
- ▶ Test & measurement

### MATERIALS

Contact: Silver plated copper alloy

▶ ▶ ▶ Example Ordering Number EG-1201A

### HOW TO ORDER



Specifications subject to change without notice.

## EG 1201



Model No.	L
EG1201	4
EG1201A	5.5

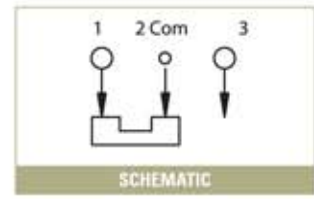
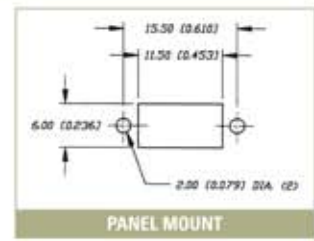
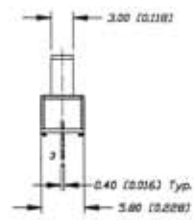
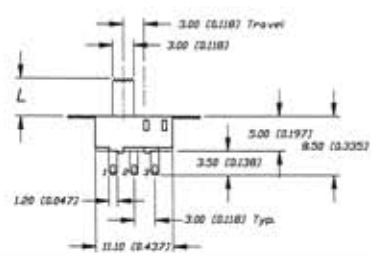
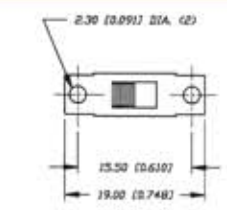

## EG 1205



Model No.	L
EG1205	4
EG1205A	5.5

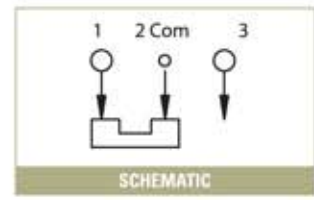
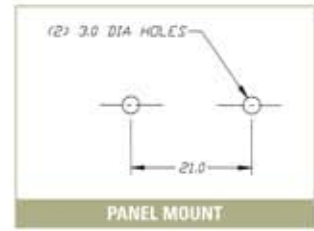
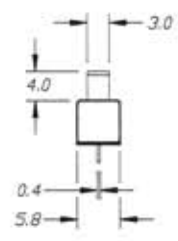
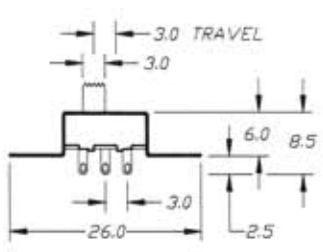
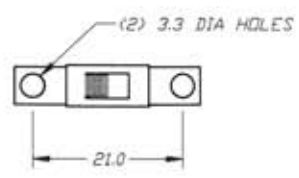



### EG 1206



Model No.	L
EG1206	3
EG1206A	6

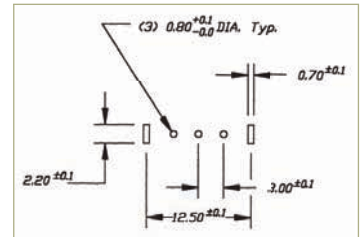
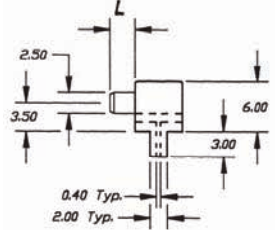
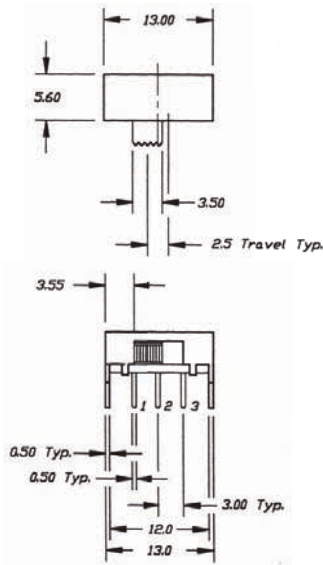

P.C. MOUNTING

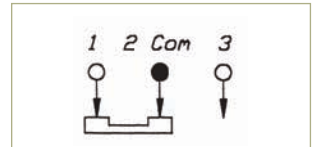

SCHEMATIC

### EG 1213

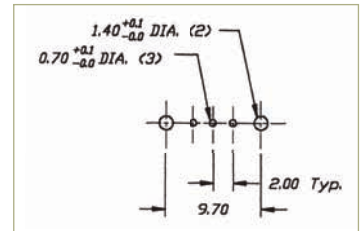
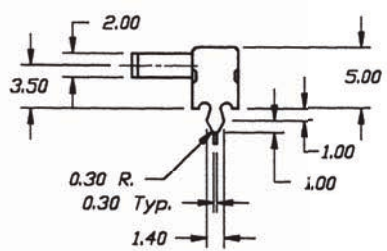
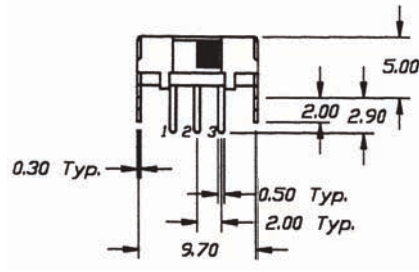
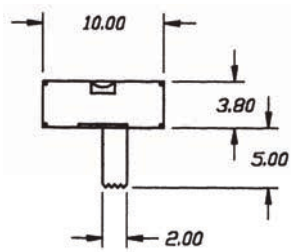

P.C. MOUNTING

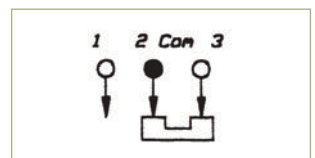

SCHEMATIC

### EG 1218

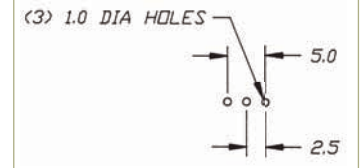
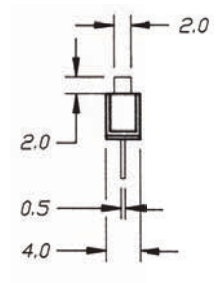
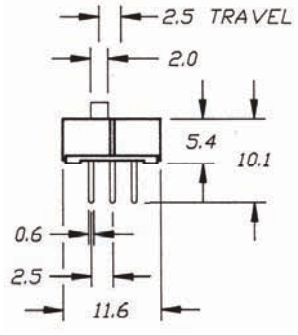

P.C. MOUNTING

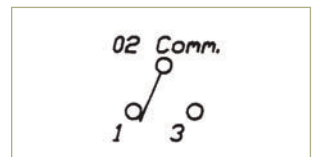

SCHEMATIC

TACT SWITCHES  
 NAVIGATION SWITCHES  
 PUSHBUTTON SWITCHES  
 TOGGLE SWITCHES  
 ROCKER SWITCHES  
 SLIDE SWITCHES  
 SNAP-ACTION SWITCHES  
 DIP SWITCHES  
 KEYLOCK SWITCHES  
 ROTARY SWITCHES  
 DETECTOR SWITCHES  
 CAP OPTIONS



# SERIES EG SWITCHES

## SLIDE SWITCHES

TACT SWITCHES

NAVIGATION SWITCHES

PUSHBUTTON SWITCHES

TOGGLE SWITCHES

ROCKER SWITCHES

SLIDE SWITCHES

SNAP-ACTION SWITCHES

DIP SWITCHES

KEYLOCK SWITCHES

ROTARY SWITCHES

DETECTOR SWITCHES

CAP OPTIONS

### EG 1224

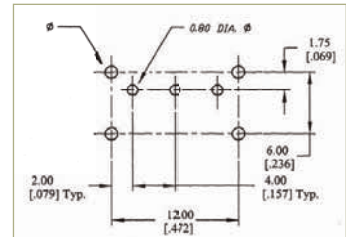
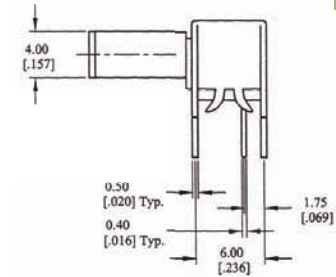
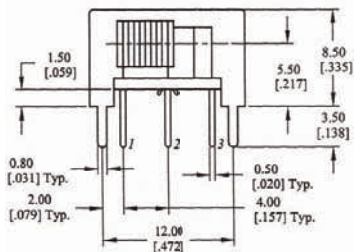
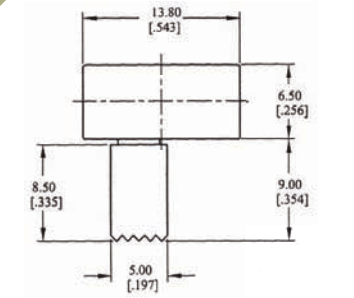

P.C. MOUNTING

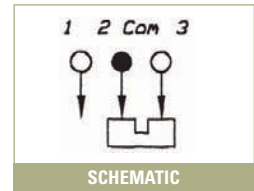

SCHEMATIC

### EG 1247

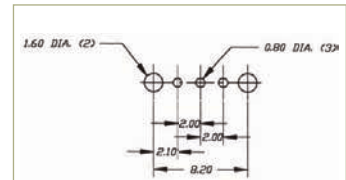
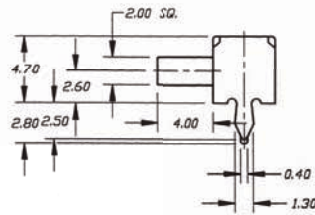
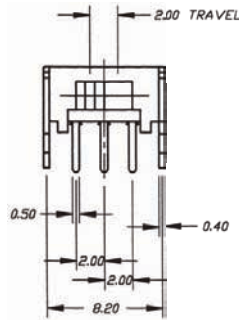
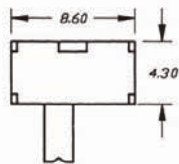

P.C. MOUNTING

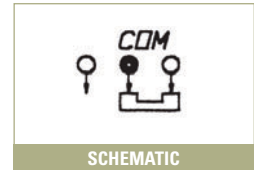

SCHEMATIC

### EG 1248

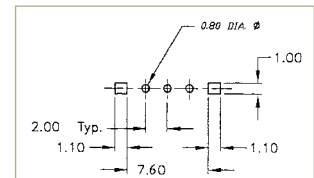
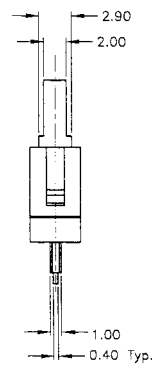
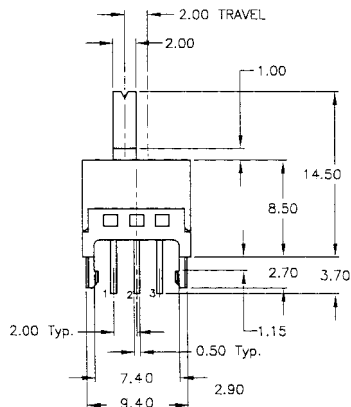
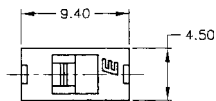

P.C. MOUNTING

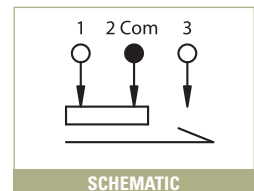

SCHEMATIC



# EG 1249

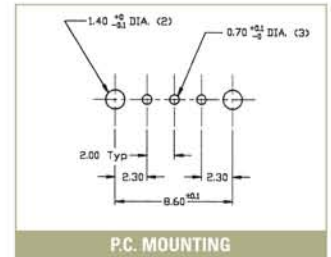
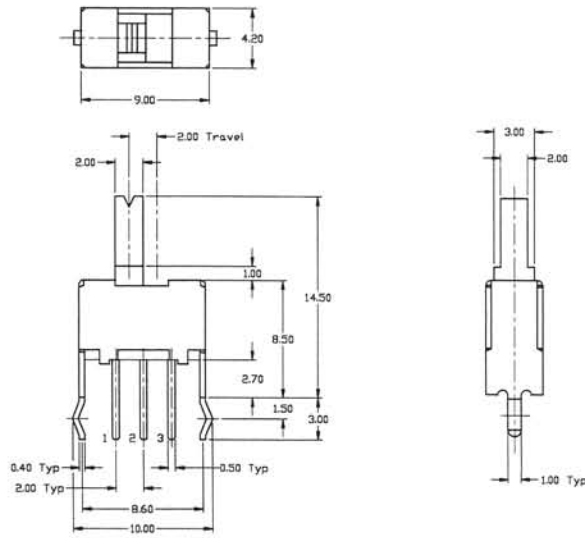

P.C. MOUNTING

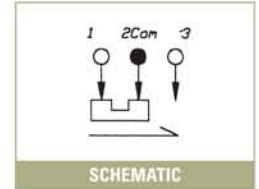

SCHEMATIC

- TACT SWITCHES
- NAVIGATION SWITCHES
- PUSHBUTTON SWITCHES
- TOGGLE SWITCHES
- ROCKER SWITCHES
- SLIDE SWITCHES**
- SNAP-ACTION SWITCHES
- DIP SWITCHES
- KEYLOCK SWITCHES
- ROTARY SWITCHES
- DETECTOR SWITCHES
- CAP OPTIONS



# SERIES EG SWITCHES

## SLIDE SWITCHES

TACT SWITCHES

NAVIGATION SWITCHES

PUSHBUTTON SWITCHES

TOGGLE SWITCHES

ROCKER SWITCHES

SLIDE SWITCHES

SNAP-ACTION SWITCHES

DIP SWITCHES

KEYLOCK SWITCHES

ROTARY SWITCHES

DETECTOR SWITCHES

CAP. OPTIONS

### EG 1270

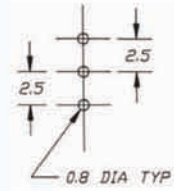
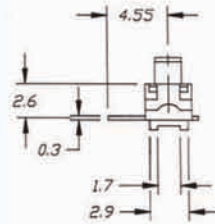
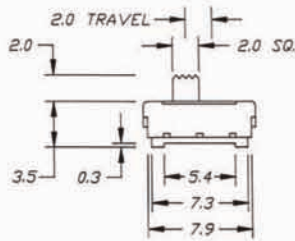
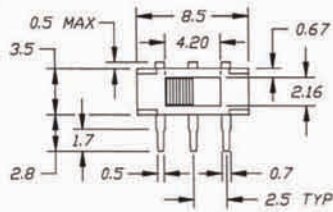

P.C. MOUNTING

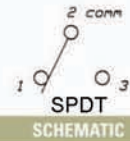

SPDT SCHEMATIC

### EG 1271



Model No.	L
EG1271	2
EG1271A	4.4

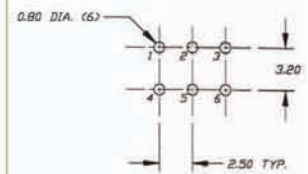
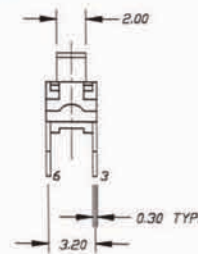
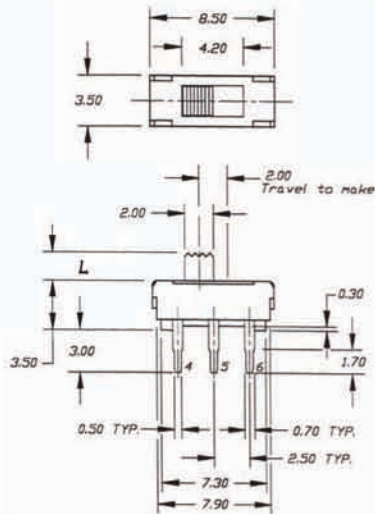

P.C. MOUNTING

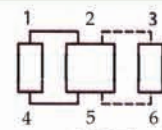

SPDT SCHEMATIC



### EG 1307

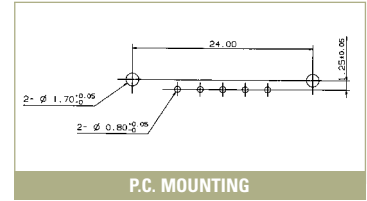
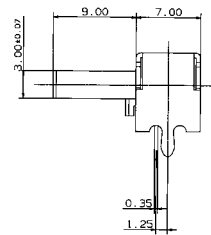
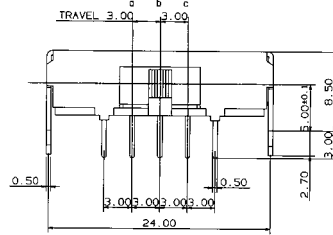
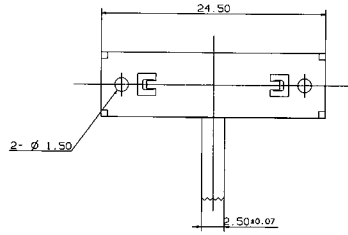

P.C. MOUNTING

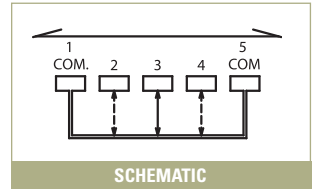

SCHEMATIC

### EG 1313

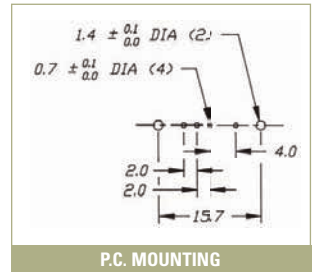
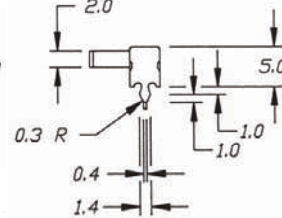
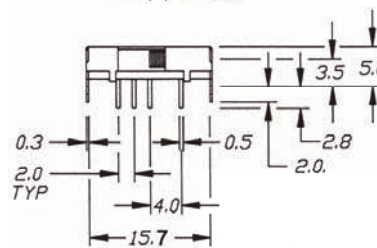
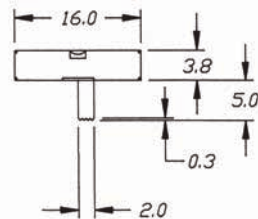

P.C. MOUNTING

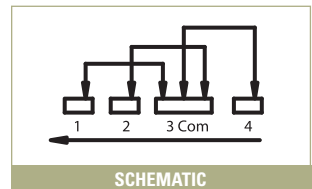

SCHEMATIC

### EG 2201

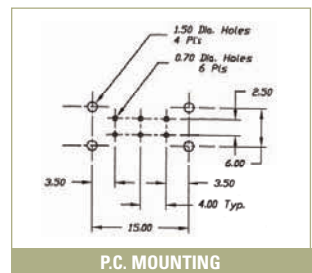
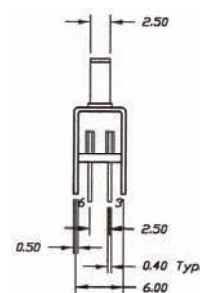
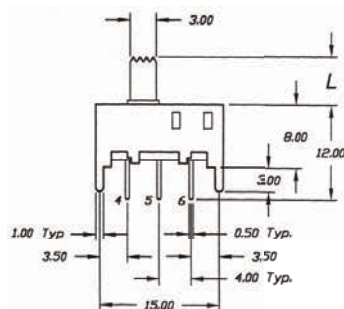
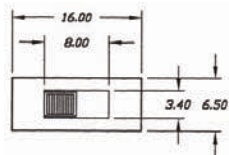

P.C. MOUNTING

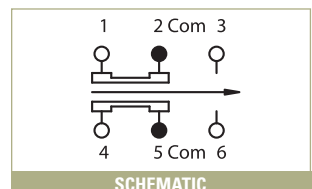

SCHEMATIC

Model No.	L
EG2201	3
EG2201A	6
EG2201B	9
EG2201C	12
EG2201D	4.5



# SERIES EG SWITCHES

## SLIDE SWITCHES

TACT SWITCHES

NAVIGATION SWITCHES

PUSHBUTTON SWITCHES

TOGGLE SWITCHES

ROCKER SWITCHES

SLIDE SWITCHES

SNAP-ACTION SWITCHES

DIP SWITCHES

KEYLOCK SWITCHES

ROTARY SWITCHES

DETECTOR SWITCHES

CAP OPTIONS

### EG 2205



Model No.	L
EG2205	4
EG2205A	2

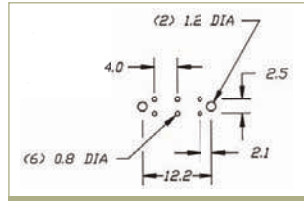
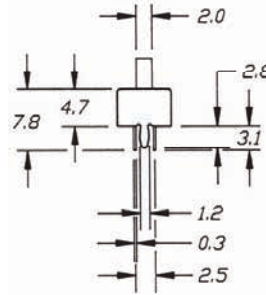
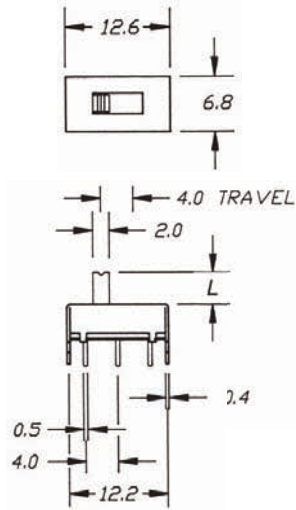

P.C. MOUNTING

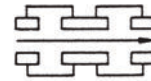

SCHEMATIC

### EG 2207

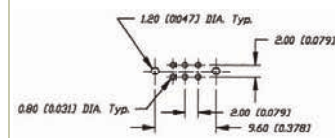
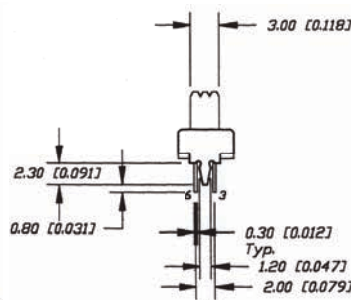
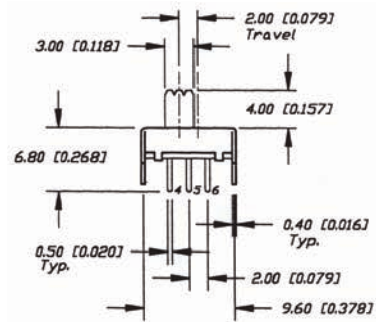
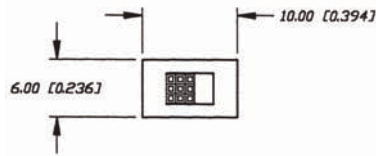

P.C. MOUNTING

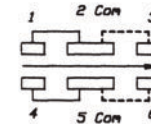

SCHEMATIC



### EG 2208



Model No.	L
EG2208	4
EG2208A	6

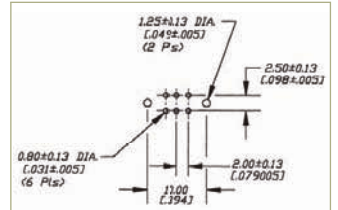
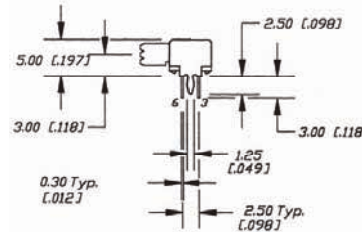
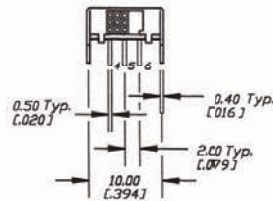
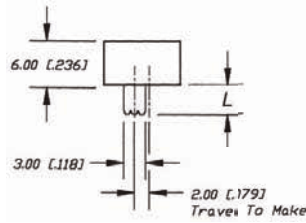

P.C. MOUNTING

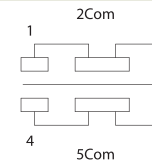

SCHEMATIC

### EG 2209



Model No.	L
EG2209	2
EG2209A	4

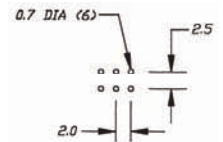
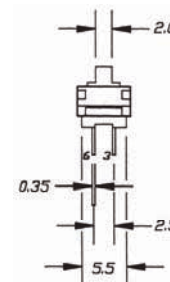
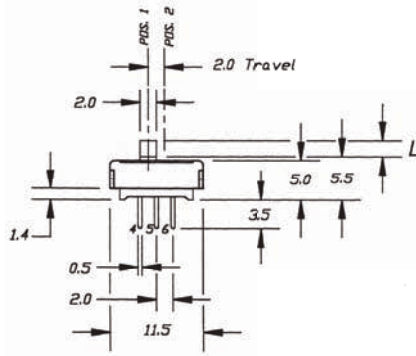
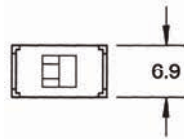

P.C. MOUNTING

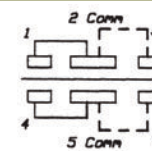

SCHEMATIC

### EG 2210

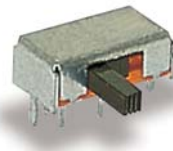

Model No.	L
EG2210	6
EG2210A	4
EG2210D	2

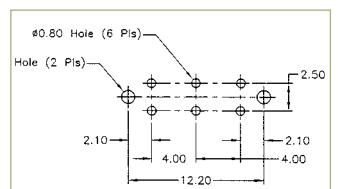
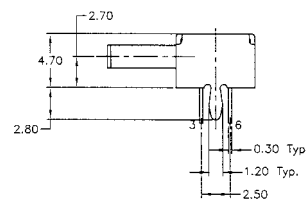
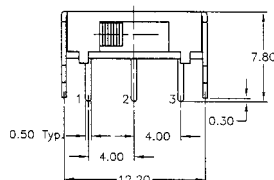
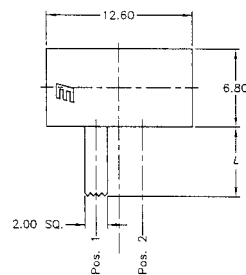

P.C. MOUNTING

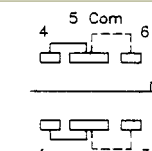

SCHEMATIC





# SERIES EG SWITCHES

## SLIDE SWITCHES

TACT SWITCHES

NAVIGATION SWITCHES

PUSHBUTTON SWITCHES

TOGGLE SWITCHES

ROCKER SWITCHES

SLIDE SWITCHES

SNAP-ACTION SWITCHES

DIP SWITCHES

KEYLOCK SWITCHES

ROTARY SWITCHES

DETECTOR SWITCHES

CAP OPTIONS

### EG 2211

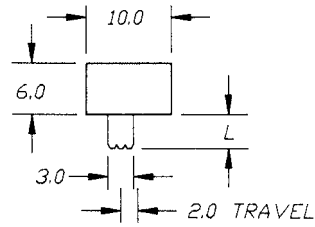

Model No.	L
EG2211	4
EG2211A	2

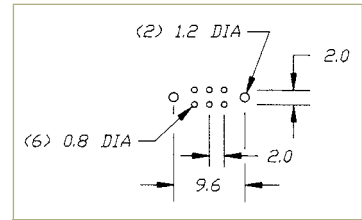
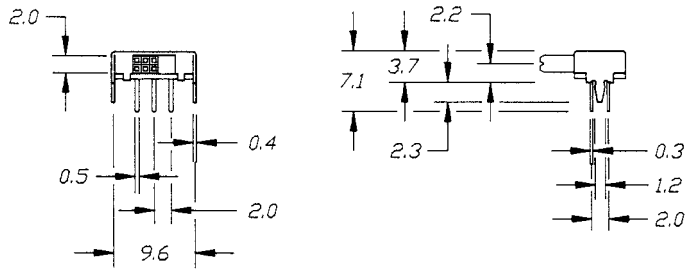

P.C. MOUNTING

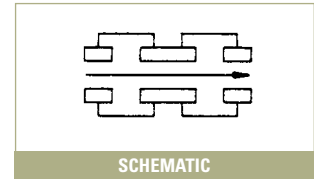

SCHEMATIC

### EG 2214

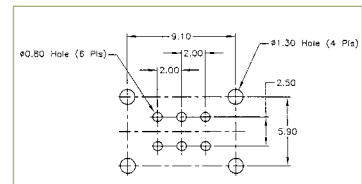
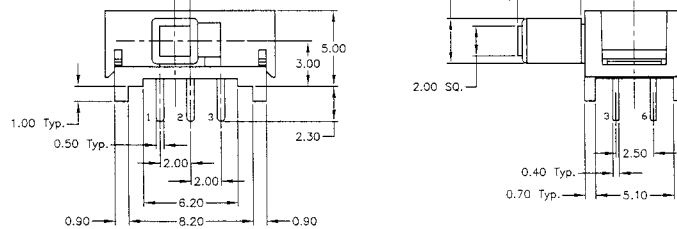
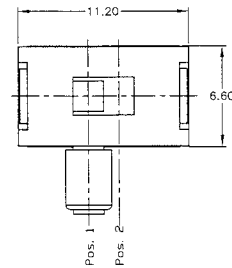

P.C. MOUNTING

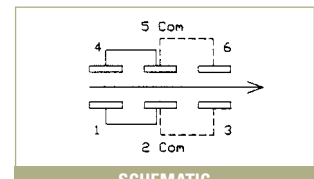

SCHEMATIC

### EG 2215

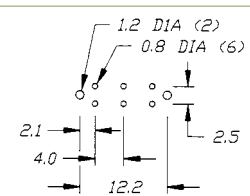
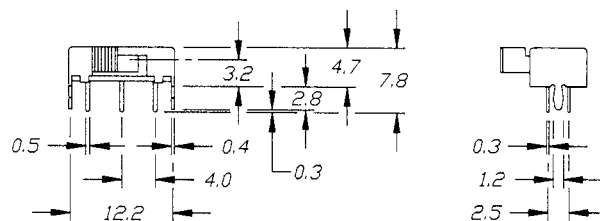
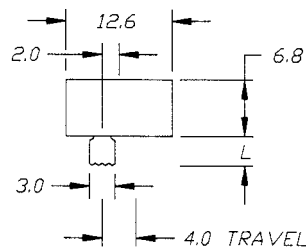

P.C. MOUNTING

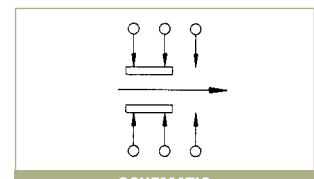

SCHEMATIC

Model No.	L
EG2215	3.5
EG2215A	6



### EG 2219

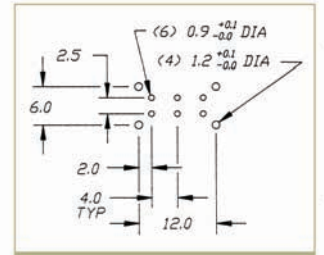
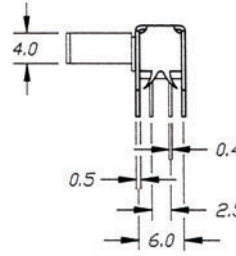
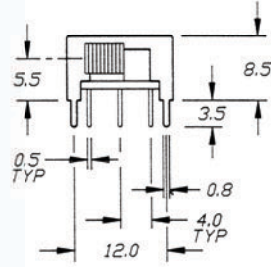
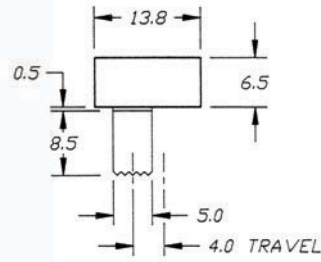

P.C. MOUNTING

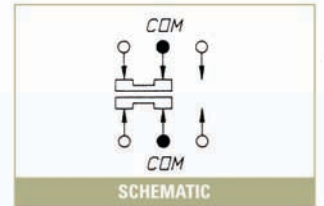

SCHEMATIC

### EG 2301



Model No.	L
EG2301	3
EG2301A	6
EG2301B	9
EG2301C	12

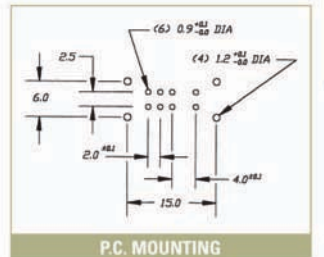
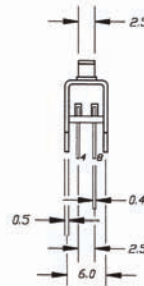
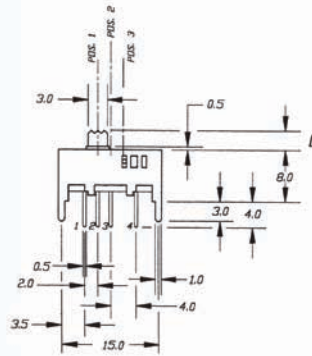
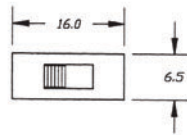

P.C. MOUNTING

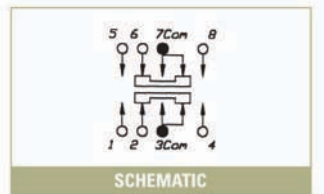

SCHEMATIC

TACT SWITCHES  
 NAVIGATION SWITCHES  
 PUSHBUTTON SWITCHES  
 TOGGLE SWITCHES  
 ROCKER SWITCHES  
 SLIDE SWITCHES  
 SNAP-ACTION SWITCHES  
 DIP SWITCHES  
 SWITCHES  
 SWITCHES  
 OPTIONS



# SERIES EG SWITCHES

## SLIDE SWITCHES

TACT SWITCHES

NAVIGATION SWITCHES

PUSHBUTTON SWITCHES

TOGGLE SWITCHES

ROCKER SWITCHES

SLIDE SWITCHES

SNAP-ACTION SWITCHES

DIP SWITCHES

KEYLOCK SWITCHES

ROTARY SWITCHES

DETECTOR SWITCHES

CAP OPTIONS

### EG 2305



Model No.	L
EG2305	4
EG2305A	2

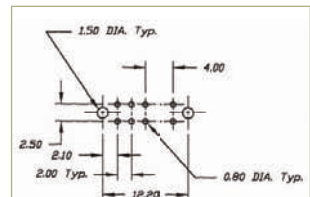
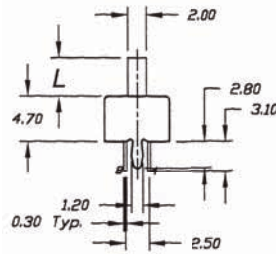
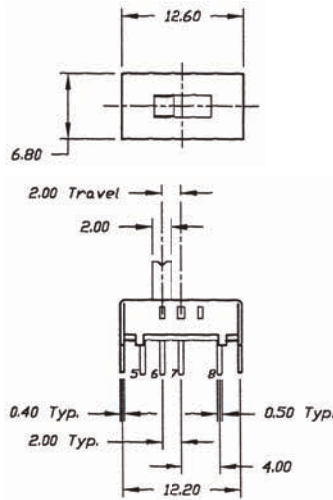

P.C. MOUNTING

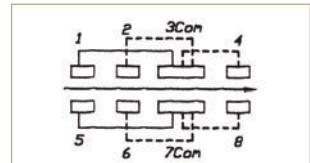

SCHEMATIC

### EG 2308



Model No.	L
EG2308	4
EG2308A	6

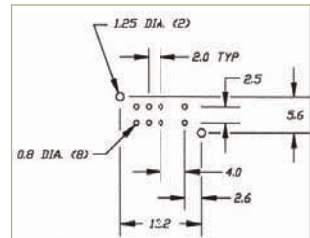
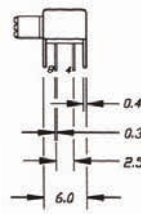
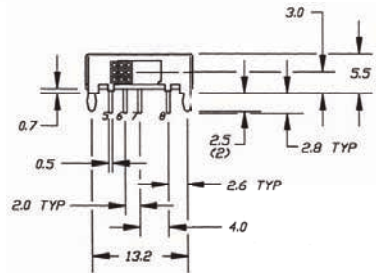
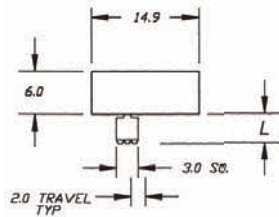

P.C. MOUNTING

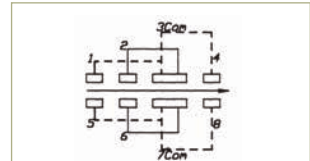

SCHEMATIC

### EG 2310



Model No.	L
EG2310	6
EG2310A	4

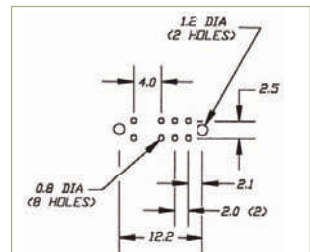
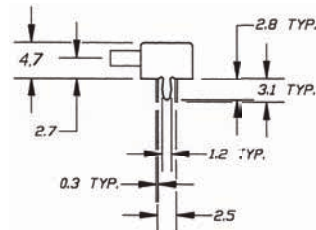
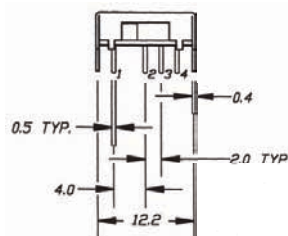
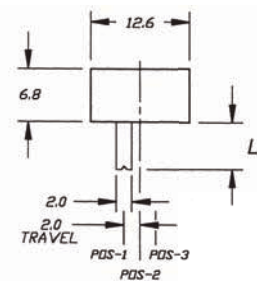

P.C. MOUNTING

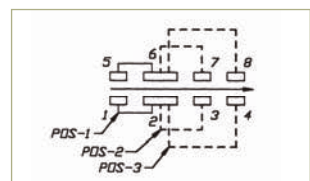

SCHEMATIC



### EG 2315



Model No.	L
EG2315	3.5
EG2315A	6

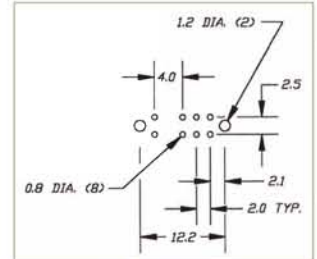
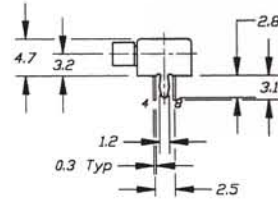
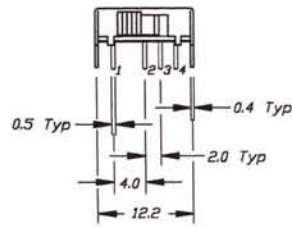
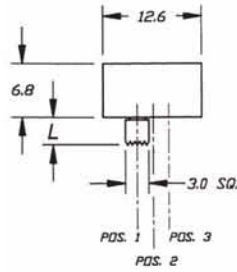

P.C. MOUNTING

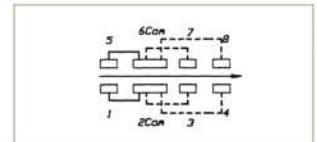

SCHEMATIC

### EG 2319

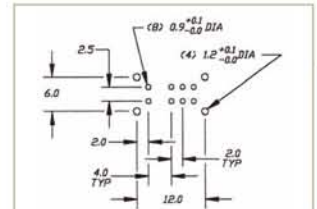
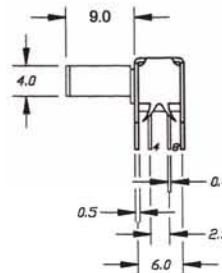
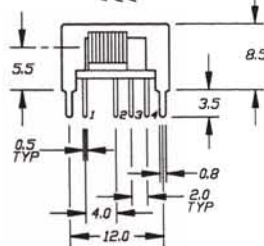
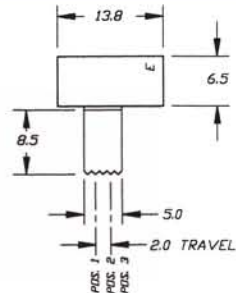

P.C. MOUNTING

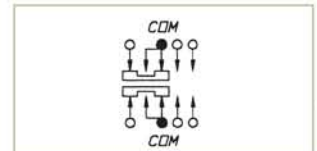

SCHEMATIC

### EG 2322

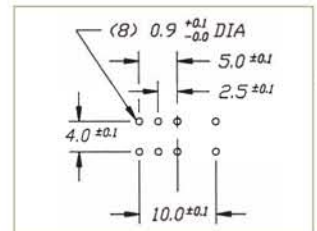
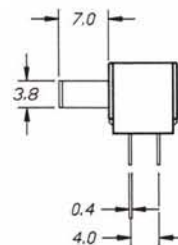
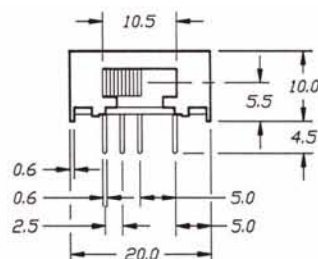
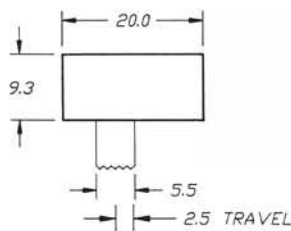

P.C. MOUNTING

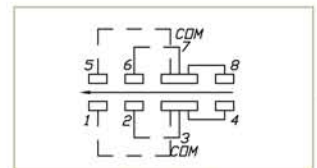

SCHEMATIC

TACT SWITCHES  
 NAVIGATION SWITCHES  
 PUSHBUTTON SWITCHES  
 TOGGLE SWITCHES  
 ROCKER SWITCHES  
 SLIDE SWITCHES  
 SNAP-ACTION SWITCHES  
 DIP SWITCHES  
 KEYLOCK SWITCHES  
 ROTARY SWITCHES  
 DETECTOR SWITCHES  
 CAP OPTIONS



# SERIES EG SWITCHES

## SLIDE SWITCHES

TACT SWITCHES

NAVIGATION SWITCHES

PUSHBUTTON SWITCHES

TOGGLE SWITCHES

ROCKER SWITCHES

SLIDE SWITCHES

SNAP-ACTION SWITCHES

DIP SWITCHES

KEYLOCK SWITCHES

ROTARY SWITCHES

DETECTOR SWITCHES

CAP. OPTIONS

### EG 2325



Model No.	L
EG2325	2
EG2325A	6

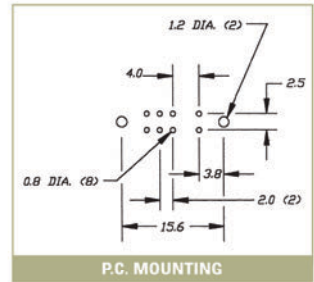
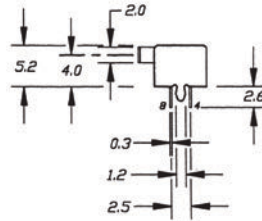
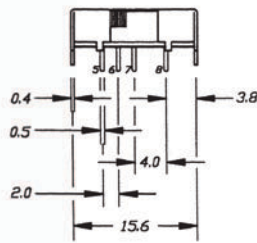
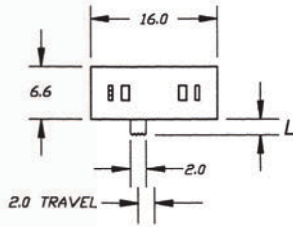

P.C. MOUNTING

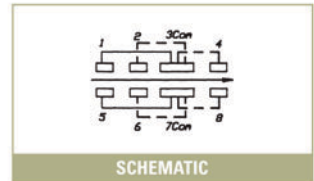

SCHEMATIC

## EG 4208



Model No.	L
EG4208	4
EG4208A	6

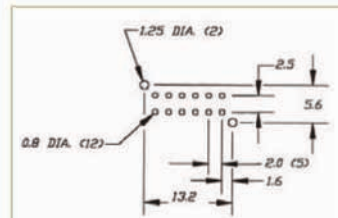
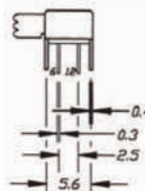
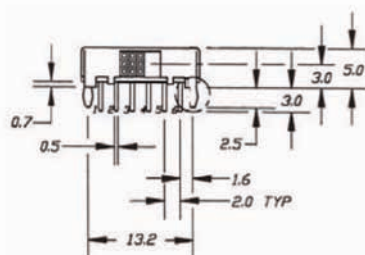
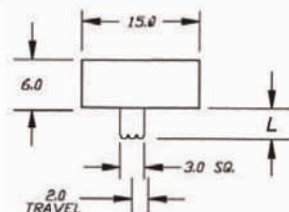

P.C. MOUNTING



SCHEMATIC

## EG 4311

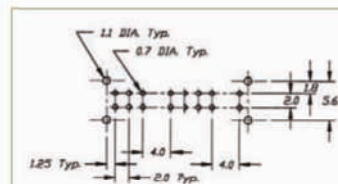
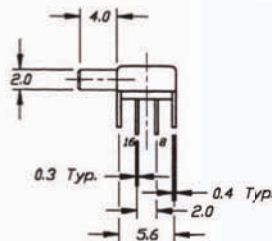
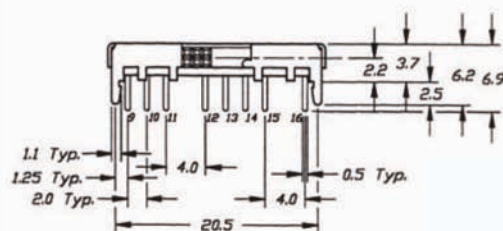
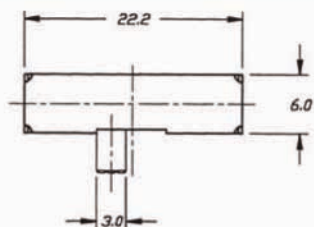

P.C. MOUNTING

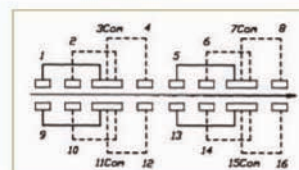

SCHEMATIC



# SERIES EG SWITCHES

## SLIDE SWITCHES

TACT SWITCHES

NAVIGATION SWITCHES

PUSHBUTTON SWITCHES

TOGGLE SWITCHES

ROCKER SWITCHES

SLIDE SWITCHES

SNAP-ACTION SWITCHES

DIP SWITCHES

KEYLOCK SWITCHES

ROTARY SWITCHES

DETECTOR SWITCHES

CAP OPTIONS

### EG 4319

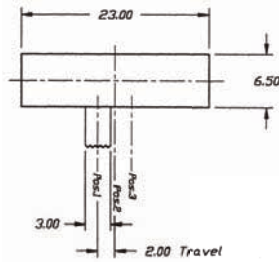
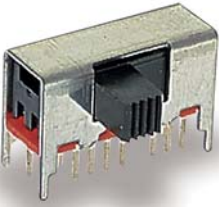

Model No.	L
EG4319	5
EG4319A	6

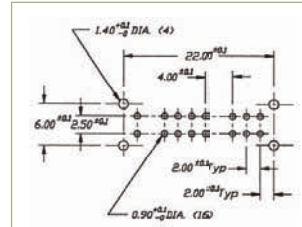
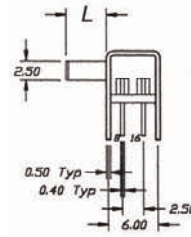
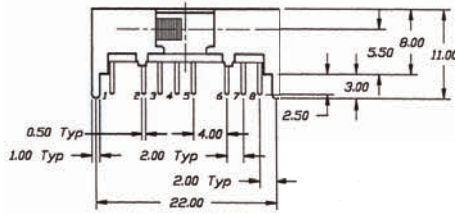

P.C. MOUNTING

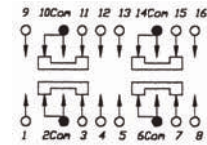

SCHEMATIC

### EG 6201

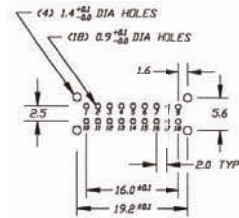
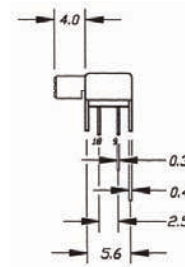
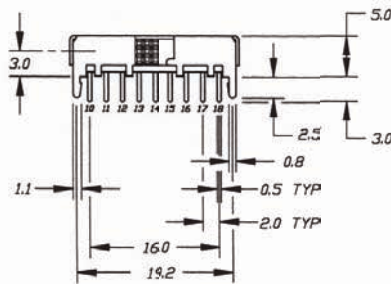
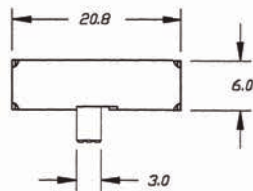

P.C. MOUNTING

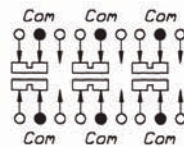

SCHEMATIC