

# SERIES KO SWITCHES

## KEYLOCK SWITCHES

TACT SWITCHES

NAVIGATION SWITCHES

PUSHBUTTON SWITCHES

TOGGLE SWITCHES

ROCKER SWITCHES

SLIDE SWITCHES

SNAP-ACTION SWITCHES

DIP SWITCHES

KEYLOCK SWITCHES

ROTARY SWITCHES

DETECTOR SWITCHES

CAP OPTIONS



### SPECIFICATIONS

Contact Rating:	As per individual model number
Initial Contact Resistance:	10 mΩ Max.
Insulation Resistance:	As per individual model number
Dielectric Strength:	As per individual model number

### MATERIALS

Housing and Cylinder:	Die cast zinc alloy. Finish dependent upon individual model number
Contact:	Silver plated copper alloy
Keys:	As per individual model number

### FEATURES & BENEFITS

- ▶ Variety of size and product package options
- ▶ Barrel and flat key options
- ▶ Wide variety of key code options

### APPLICATIONS/MARKETS

- ▶ Security applications
- ▶ Personal transportation vehicles
- ▶ Elevator controls



### HOW TO ORDER



Example Ordering Number  
KO-103B

Specifications subject to change without notice.

## KO 103

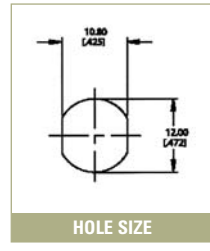
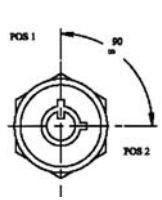
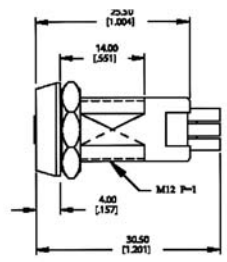

### FEATURES & BENEFITS

- ▶ Zinc alloy die cast housing and cylinder, chrome plated
- ▶ Zinc alloy keys, chrome plated
- ▶ Silver plated contacts and terminals
- ▶ 200 combinations available

### SPECIFICATIONS

Ratings:	1A @ 125 VAC 0.5A @ 250 VAC
Contact Resistance:	20 mΩ max. initial @ 2-4 VDC, 100 mA
Insulation Resistance:	200 MΩ min.
Dielectric Strength:	1,500 V rms @ sea level

Part Number	Lock Configuration (as viewed from key end)	Connected Terminals			Key Pull Possible
		Pos. 1	Pos. 2	Pos. 3	
KO103A	90° indexing	OFF	1-2		Pos. 1
KO103B	90° indexing	OFF	1-2		Pos. 1, Pos. 2
KO103C	90° indexing	1-2	3-4		Pos. 1
KO103D	90° indexing	1-2	3-4		Pos. 1, Pos. 2
KO103E	90° indexing	OFF	1-2		Pos. 1

• = Detent Position    ○ = Keypull Possible    ▼ = Momentary

## KO 104

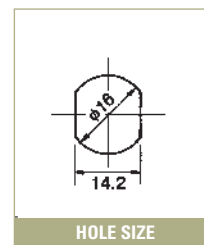
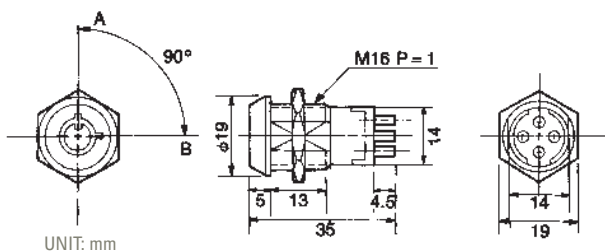



### FEATURES & BENEFITS

- ▶ Zinc alloy die cast housing and cylinder, chrome plated
- ▶ Zinc alloy keys, chrome plated, with plastic cover
- ▶ Silver plated contacts and terminals
- ▶ 10,000 combinations available

### SPECIFICATIONS

Ratings:	3A @ 125 VAC 1.5A @ 250 VAC
Contact Resistance:	20 mΩ max. initial @ 2-4 VDC, 100 mA
Insulation Resistance:	200 MΩ min.
Dielectric Strength:	1,500 V rms @ sea level

Part Number	Lock Configuration (as viewed from key end)	Connected Terminals			Key Pull Possible
		Pos. 1	Pos. 2	Pos. 3	
KO104A	 90° indexing	1-2	3-4		Pos. 1
KO104B	 90° indexing	1-2	3-4		Pos. 1, Pos. 2

• = Detent Position    ⊙ = Keypull Possible    ▼ = Momentary

## KO 105

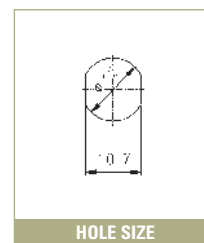
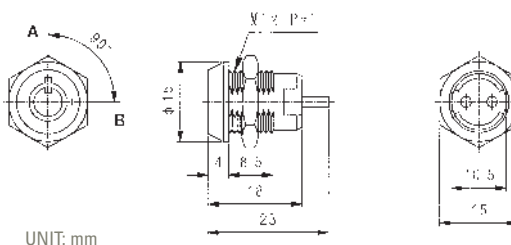



### FEATURES & BENEFITS

- ▶ Zinc alloy die cast housing and cylinder, chrome plated
- ▶ Steel made tubular keys, nickel plated, with plastic cover
- ▶ Silver plated contacts and terminals
- ▶ 100 combinations available

### SPECIFICATIONS

Ratings:	1A @ 125 VAC 0.5A @ 250 VAC
Contact Resistance:	20 mΩ max. initial @ 2-4 VDC, 100 mA
Insulation Resistance:	200 MΩ min.
Dielectric Strength:	1,500 V rms @ sea level

Part Number	Lock Configuration (as viewed from key end)	Connected Terminals			Key Pull Possible
		Pos. 1	Pos. 2	Pos. 3	
KO105A	 90° indexing	OFF	1-2		Pos. 1, Pos. 2
KO105B	 90° indexing	1-2	3-4		Pos. 1, Pos. 2

• = Detent Position    ⊙ = Keypull Possible    ▼ = Momentary

# SERIES KO SWITCHES

## KEYLOCK SWITCHES

### KO 106

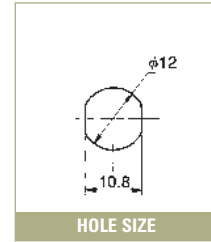
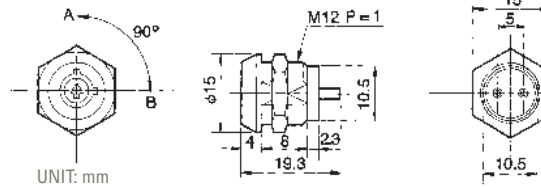

#### FEATURES & BENEFITS

- ▶ Zinc alloy die cast housing and cylinder, chrome plated
- ▶ Zinc alloy keys, chrome plated
- ▶ Silver plated contacts and terminals
- ▶ 1 combination available

#### SPECIFICATIONS

Ratings:	1A @ 125 VAC 0.5A @ 250 VAC
Contact Resistance:	20 mΩ max. initial @ 2-4 VDC, 100 mA
Insulation Resistance:	200 MΩ min.
Dielectric Strength:	1,500 V rms @ sea level

Part Number	Lock Configuration (as viewed from key end)	Connected Terminals			Key Pull Possible
		Pos. 1	Pos. 2	Pos. 3	
KO106A	90° indexing	OFF	1-2		Pos. 1, Pos. 2

• = Detent Position    ⊙ = Keypull Possible    ▼ = Momentary

### KO 107

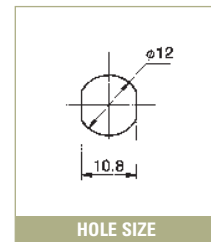
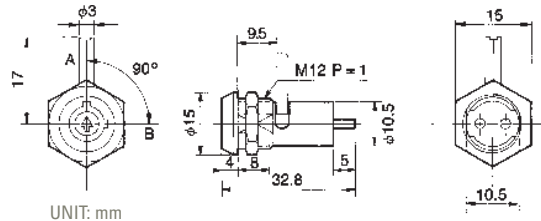

#### FEATURES & BENEFITS

- ▶ Zinc alloy die cast housing and cylinder, chrome plated
- ▶ Zinc alloy keys, chrome plated
- ▶ Silver plated contacts and terminals
- ▶ L dimension per customer requirement, 13 mm is standard
- ▶ 6 combinations available

#### SPECIFICATIONS

Ratings:	1A @ 125 VAC 0.5A @ 250 VAC
Contact Resistance:	20 mΩ max. initial @ 2-4 VDC, 100 mA
Insulation Resistance:	200 MΩ min.
Dielectric Strength:	1,500 V rms @ sea level

Part Number	Lock Configuration (as viewed from key end)	Connected Terminals			Key Pull Possible
		Pos. 1	Pos. 2	Pos. 3	
KO107A	90° indexing	OFF	1-2		Pos. 1, Pos. 2

• = Detent Position    ⊙ = Keypull Possible    ▼ = Momentary

## KO 113

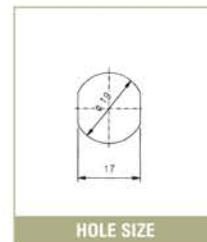
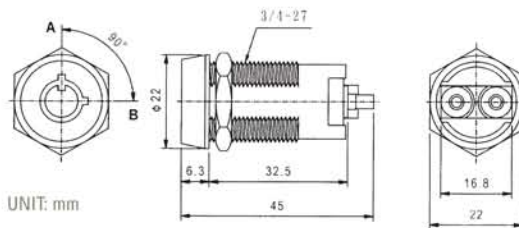

### FEATURES & BENEFITS

- ▶ Zinc alloy die cast housing and cylinder, chrome plated
- ▶ Steel made tubular keys, nickel plated,
- ▶ Silver plated contacts and terminals
- ▶ 50,000 combinations available

### SPECIFICATIONS

Ratings:	4A @ 125 VAC 2A @ 250 VAC
Contact Resistance:	20 mΩ max. initial @ 2-4 VDC, 100 mA
Insulation Resistance:	200 MΩ min.
Dielectric Strength:	1,500 V rms @ sea level

Part Number	Lock Configuration (as viewed from key end)	Connected Terminals			Key Pull Possible
		Pos. 1	Pos. 2	Pos. 3	
KO113A	⊙, 90° indexing	OFF	1-2		Pos. 1
KO113B	⊙, 90° indexing	OFF	1-2		Pos. 1, Pos. 2
KO113C	⊙, 90° indexing	OFF	1-2		Pos. 1

• = Detent Position   ⊙ = Keypull Possible   ▼ = Momentary

## KO 114

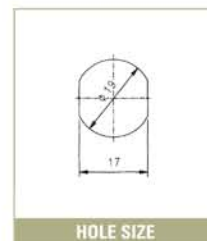
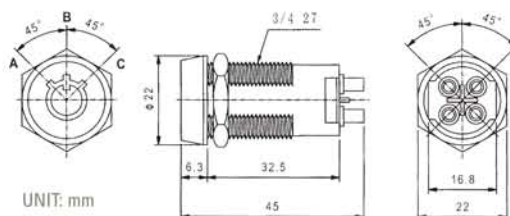

### FEATURES & BENEFITS

- ▶ Zinc alloy die cast housing and cylinder, chrome plated
- ▶ Steel made tubular keys, nickel plated
- ▶ Silver plated contacts and terminals
- ▶ 50,000 combinations available

### SPECIFICATIONS

Ratings:	4A @ 125 VAC 2A @ 250 VAC
Contact Resistance:	20 mΩ max. initial @ 2-4 VDC, 100 mA
Insulation Resistance:	200 MΩ min.
Dielectric Strength:	1,500 V rms @ sea level

Part Number	Lock Configuration (as viewed from key end)	Connected Terminals			Key Pull Possible
		Pos. 1	Pos. 2	Pos. 3	
KO114A	⊙, 45°-45° indexing	1-3	OFF	2-4	Pos. 1, Pos. 2, Pos. 3
KO114B	⊙, 45°-90° indexing	OFF	1-3	2-4	Pos. 1, Pos. 2, Pos. 3
KO114C	⊙, 90° indexing	1-3	2-4		Pos. 1, Pos. 2
KO114D	⊙, 45° indexing	OFF	1-3, 2-4		Pos. 1, Pos. 2

• = Detent Position   ⊙ = Keypull Possible   ▼ = Momentary

# SERIES KO SWITCHES

## KEYLOCK SWITCHES

TACT SWITCHES

NAVIGATION SWITCHES

PUSHBUTTON SWITCHES

TOGGLE SWITCHES

ROCKER SWITCHES

SLIDE SWITCHES

SNAP-ACTION SWITCHES

DIP SWITCHES

KEYLOCK SWITCHES

ROTARY SWITCHES

DETECTOR SWITCHES

CAP OPTIONS

### KO 117

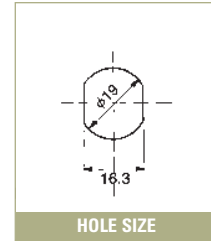
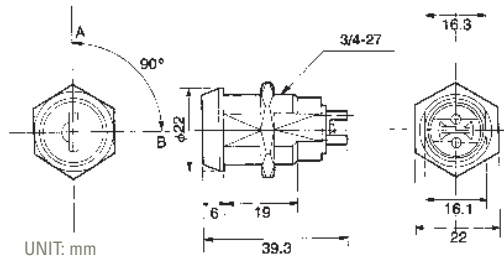

#### FEATURES & BENEFITS

- ▶ Zinc alloy die cast housing, chrome plated
- ▶ 5-Disk tumblers mechanism, with dust shutter
- ▶ Reversible double cut key, brass made, nickel plated
- ▶ Silver plated contacts and terminals
- ▶ 150 combinations available

#### SPECIFICATIONS

Ratings:	4A @ 125 VAC 2A @ 250 VAC
Contact Resistance:	20 mΩ max. initial @ 2-4 VDC, 100 mA
Insulation Resistance:	200 MΩ min.
Dielectric Strength:	1,500 V rms @ sea level

Part Number	Lock Configuration (as viewed from key end)	Connected Terminals			Key Pull Possible
		Pos. 1	Pos. 2	Pos. 3	
KO117A	$\overset{1}{\odot} \text{---} \underset{2}{\ominus}$ 90° indexing	OFF	1-2		Pos. 1, Pos. 2

• = Detent Position    ◯ = Keypull Possible    ▼ = Momentary

### KO 118

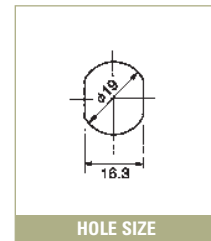
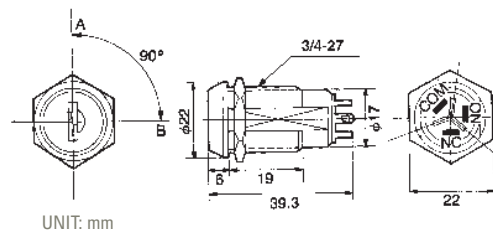

#### FEATURES & BENEFITS

- ▶ Zinc alloy die cast housing, chrome plated
- ▶ 5-Disk tumblers mechanism, with dust shutter
- ▶ Reversible double cut key, brass made, nickel plated
- ▶ Silver plated contacts and terminals
- ▶ 150 combinations available

#### SPECIFICATIONS

Ratings:	4A @ 125 VAC 2A @ 250 VAC
Contact Resistance:	20 mΩ max. initial @ 2-4 VDC, 100 mA
Insulation Resistance:	200 MΩ min.
Dielectric Strength:	1,500 V rms @ sea level

Part Number	Lock Configuration (as viewed from key end)	Connected Terminals			Key Pull Possible
		Pos. 1	Pos. 2	Pos. 3	
KO118A	$\overset{1}{\odot} \text{---} \underset{2}{\ominus}$ 90° indexing	1-2	3-4		Pos. 1, Pos. 2

• = Detent Position    ◯ = Keypull Possible    ▼ = Momentary

## KO 119

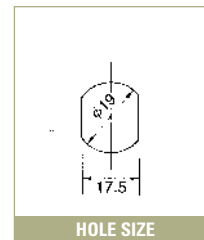
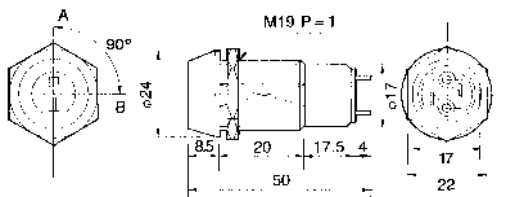



### FEATURES & BENEFITS

- ▶ Zinc alloy die cast housing and cylinder
- ▶ 5-Disk tumblers mechanism
- ▶ Reversible double cut key
- ▶ Silver plated contacts and terminals
- ▶ 150 combinations available

### SPECIFICATIONS

Ratings:	4A @ 125 VAC 2A @ 250 VAC
Contact Resistance:	20 mΩ max. initial @ 2-4 VDC, 100 mA
Insulation Resistance:	200 MΩ min.
Dielectric Strength:	1,500 V rms @ sea level

Part Number	Lock Configuration (as viewed from key end)	Connected Terminals			Key Pull Possible
		Pos. 1	Pos. 2	Pos. 3	
KO119A	 90° indexing	OFF	1-2		Pos. 1
KO119B	 90° indexing	OFF	1-2		Pos. 1, Pos. 2
KO119C	 90° indexing	OFF	1-2		Pos. 1

• = Detent Position    ⊙ = Keypull Possible    ▼ = Momentary

## KO 124

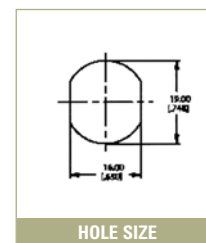
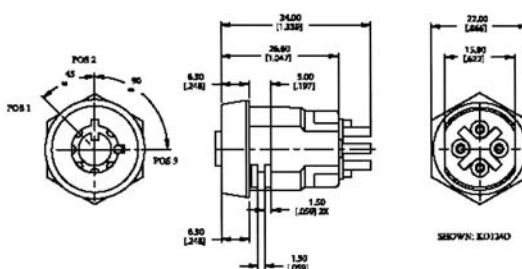



### FEATURES & BENEFITS

- ▶ Zinc alloy die cast housing and cylinder, satin chrome plated
- ▶ Steel made tubular keys, nickel plated
- ▶ Silver plated contacts and terminals
- ▶ 50,000 combinations available

### SPECIFICATIONS

Ratings:	2A @ 125 VAC 1A @ 250 VAC
Contact Resistance:	20 mΩ max. initial @ 2-4 VDC, 100 mA
Insulation Resistance:	200 MΩ min.
Dielectric Strength:	1,500 V rms @ sea level

Part Number	Lock Configuration (as viewed from key end)	Connected Terminals				Key Pull Possible
		Pos. 1	Pos. 2	Pos. 3	Pos. 4	
KO124A	 90° indexing		OFF	1-2		Pos. 2, Pos. 3
KO124C	 90° indexing		1-2	3-4		Pos. 2, Pos. 3
KO124D	 45°/90° indexing	OFF	1-2	3-4		Pos. 1, Pos. 2, Pos. 3

• = Detent Position    ⊙ = Keypull Possible    ▼ = Momentary

# SERIES KO SWITCHES

## KEYLOCK SWITCHES

TACT SWITCHES

NAVIGATION SWITCHES

PUSHBUTTON SWITCHES

TOGGLE SWITCHES

ROCKER SWITCHES

SLIDE SWITCHES

SNAP-ACTION SWITCHES

DIP SWITCHES

KEYLOCK SWITCHES

ROTARY SWITCHES

DETECTOR SWITCHES

CAP OPTIONS

### KO 126

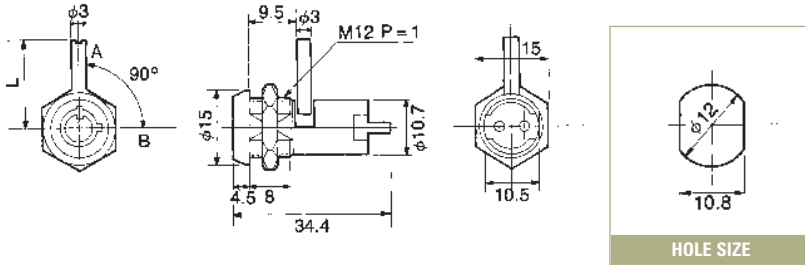

#### FEATURES & BENEFITS

- ▶ Zinc alloy die cast housing, chrome plated
- ▶ Brass cylinder, chrome plated
- ▶ Brass keys, nickel plated, with plastic cover
- ▶ Silver plated contacts and terminals
- ▶ 2 positions (Off-On)
- ▶ Dual-Functioned Key Lock Switch
- ▶ L dimension per customer requirement; 13mm is standard
- ▶ 200 combinations available

#### SPECIFICATIONS

Ratings:	1A @ 125 VAC 0.5A @ 250 VAC
Contact Resistance:	20 mΩ max. initial @ 2-4 VDC, 100 mA
Insulation Resistance:	200 MΩ min.
Dielectric Strength:	1,500 V rms @ sea level

Part Number	Lock Configuration (as viewed from key end)	Connected Terminals				Key Pull Possible
		Pos. 1	Pos. 2	Pos. 3	Pos. 4	
KO126A	90° indexing	OFF	1-2			Pos. 1, Pos. 2

• = Detent Position    ⊙ = Keypull Possible    ▼ = Momentary

### KO 128

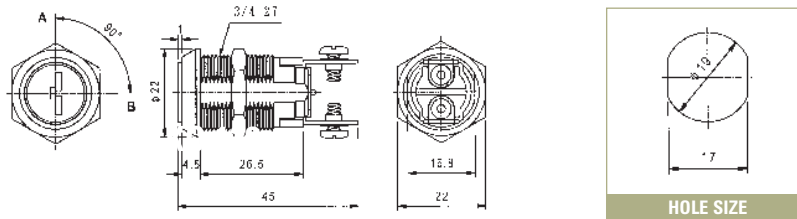

#### FEATURES & BENEFITS

- ▶ Zinc alloy die cast housing and cylinder, chrome plated
- ▶ 11 Blade criss cross tumblers.
- ▶ Reversible, double bitted keys

#### SPECIFICATIONS

Ratings:	4A @ 125 VAC 2A @ 250 VAC
Contact Resistance:	20 mΩ max. initial @ 2-4 VDC, 100 mA
Insulation Resistance:	200 MΩ min.
Dielectric Strength:	1,500 V rms @ sea level

Part Number	Lock Configuration (as viewed from key end)	Connected Terminals				Key Pull Possible
		Pos. 1	Pos. 2	Pos. 3	Pos. 4	
KO128A	90° indexing	OFF	1-2			Pos. 1
KO128B	90° indexing	OFF	1-2			Pos. 1, Pos. 2
KO128E	90° indexing	OFF	1-2			Pos. 1
KO128F	90° indexing	OFF	1-2			Pos. 1
KO128G	90° indexing	OFF	1-2			Pos. 1, Pos. 2
KO128H	90° indexing	OFF	1-2			Pos. 1

• = Detent Position    ⊙ = Keypull Possible    ▼ = Momentary

Options A, B, and E are screw terminals  
Options F, G, and H are quick connects



# KO 129

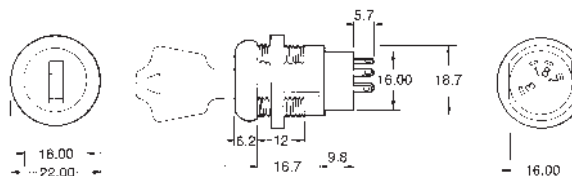

## FEATURES & BENEFITS

- ▶ Lock: bright nickel plated zinc alloy with nickel facing (black and polished chrome facing available)
- ▶ Tumbler mechanism: 4-disc tumbler cylinder
- ▶ Keys: brass with code no.
- ▶ Contacts: silver plated copper alloy
- ▶ Terminals: silver plated copper alloy
- ▶ Mounting nut: nickel plated zinc alloy



## SPECIFICATIONS

Ratings:	4A @ 125 VAC 2A @ 250 VAC
Contact Resistance:	20 mΩ max. initial @ 2-4 VDC, 100 mA
Insulation Resistance:	200 MΩ min.
Dielectric Strength:	1,500 V rms @ sea level

Part Number	Lock Configuration (as viewed from key end)	Connected Terminals					Key Pull Possible
		Pos. 1	Pos. 2	Pos. 3	Pos. 4	Pos. 5	
KO129A (SP)	45°- 90° indexing		7-8	8-1		1-3	Pos. 3, Pos. 5
KO129B (SP)	90°- 45° indexing	1-2		7-1	6-7		Pos. 1, Pos. 3
KO129C (SP)	45°- 45° indexing		1-2	8-1	7-8		Pos. 3
KO129D (DP)	45°- 45° indexing		1-2, 5-6	8-1, 4-5	7-8, 3-4		
KO129E (SP)	45° indexing			8-1	1-2		Pos. 3
KO129F (DP)	45° indexing			8-1, 4-5	1-2, 5-6		
KO129G (SP)	45° indexing		7-8	8-1			Pos. 3
KO129H (DP)	45° indexing		7-8, 3-4	8-1, 4-5			
KO129J (SP)	45°- 45° indexing		1-2	8-1	7-8		Pos. 3
KO129K (DP)	45°- 45° indexing		1-2, 5-6	8-1, 4-5	7-8, 3-4		
KO129L (SP)	45°- 45° indexing		7-8	8-1	1-2		Pos. 3
KO129M (DP)	45°- 45° indexing		7-8, 3-4	8-1, 4-5	1-2, 5-6		

\* = Detent Position    ⊙ = Keypull Possible    ▼ = Momentary

TACT SWITCHES

NAVIGATION SWITCHES

PUSHBUTTON SWITCHES

TOGGLE SWITCHES

ROCKER SWITCHES

SLIDE SWITCHES

SNAP-ACTION SWITCHES

DIP SWITCHES

KEYLOCK SWITCHES

ROTARY SWITCHES

DETECTOR SWITCHES

CAP OPTIONS



# SERIES KO SWITCHES

## KEYLOCK SWITCHES

### KO 130

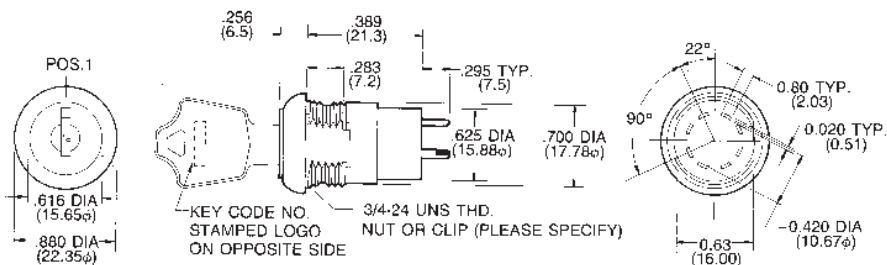

#### FEATURES & BENEFITS

- ▶ Lock: bright nickel plated zinc alloy with nickel facing (black and polished chrome facing available)
- ▶ Tumbler mechanism: 4-disc tumbler cylinder
- ▶ Keys: brass with code no.
- ▶ Contacts: silver plated copper alloy
- ▶ Terminals: silver plated copper alloy
- ▶ Contact spring: piano wire
- ▶ Mounting nut: nickel plated zinc alloy



#### SPECIFICATIONS

Ratings:	4A @ 125 VAC 2A @ 250 VAC
Contact Resistance:	20 mΩ max. initial @ 2-4 VDC, 100 mA
Insulation Resistance:	200 MΩ min.
Dielectric Strength:	1,500 V rms @ sea level

\*Anti-static models exceed 20kv DC static resistance also available

Part Number	Lock Configuration (as viewed from key end)	Connected Terminals					Key Pull Possible
		Pos. 1	Pos. 2	Pos. 3	Pos. 4	Pos. 5	
KO130A (SP)	45°-45° indexing			8-1	1-2	2-3	Pos. 3
KO130B (DP)	45°-45° indexing			8-1, 4-5	1-2, 5-6	2-3, 6-7	
KO130C (SP)	45°-45° indexing			8-1	1-2	2-3	Pos. 5
KO130D (DP)	45°-45° indexing			8-1, 4-5	1-2, 5-6	2-3, 6-7	
KO130E (SP)	45°-45° indexing			8-1	1-2	2-3	Pos. 3, Pos. 5
KO130F (DP)	45°-45° indexing			8-1, 4-5	1-2, 5-6	2-3, 6-7	
KO130G (SP)	45°-45° indexing		8-1	1-2	7-8		Pos. 3
KO130H (DP)	45°-45° indexing		8-1, 4-5	1-2, 5-6	7-8, 3-4		
KO130I (SP)	45°-45° indexing		8-1	1-2	7-8		Pos. 2, Pos. 3, Pos. 4
KO130J (DP)	45°-45° indexing		8-1, 4-5	1-2, 5-6	7-8, 3-4		
KO130K (SP)	45°-45°-45°-45° indexing	6-7	7-8	8-1	1-2	2-3	Pos. 3
KO130L (SP)	45°-45°-45°-45° indexing	6-7	7-8	8-1	1-2	2-3	
KO130M (SP)	45°-45°-45°-45° indexing	6-7	7-8	8-1	1-2	2-3	Pos. 1, Pos. 3, Pos. 5
KO130N (SP)	90° indexing			8-1		1-3	
KO130O (DP)	90° indexing			8-1, 4-5		1-3, 5-7	Pos. 3
KO130P (SP)	90° indexing			8-1		1-3	
KO130Q (DP)	90° indexing			8-1, 4-5		1-3, 5-7	Pos. 5
KO130R (SP)	90° indexing			8-1		1-3	
KO130S (DP)	90° indexing			8-1, 4-5		1-3, 5-7	
KO130T (SP)	45°-45°-90° indexing	6-7	7-8	8-1		1-3	Pos. 3
KO130U (SP)	45°-45°-90° indexing	6-7	7-8	8-1		1-3	
KO130V (SP)	45°-45°-90° indexing	6-7	7-8	8-1		1-3	Pos. 1, Pos. 3, Pos. 5
KO130Y (SP)	90°-45°-45° indexing	6-7		7-1	1-2	2-3	
KO130Z (SP)	90°-45°-45° indexing	6-7		7-1	1-2	2-3	Pos. 1, Pos. 5
KO130Z1 (SP)	90°-45°-45° indexing	6-7		7-1	1-2	2-3	
KO130Z2 (SP)	90°-90° indexing	6-7		7-1		1-3	Pos. 3
KO130Z3 (SP)	90°-90° indexing	6-7		7-1		1-3	
KO130Z4 (SP)	90°-90° indexing	6-7		7-1		1-3	Pos. 1, Pos. 3, Pos. 5

• = Detent Position    ⊙ = Keypull Possible    ▼ = Momentary



## KO 131

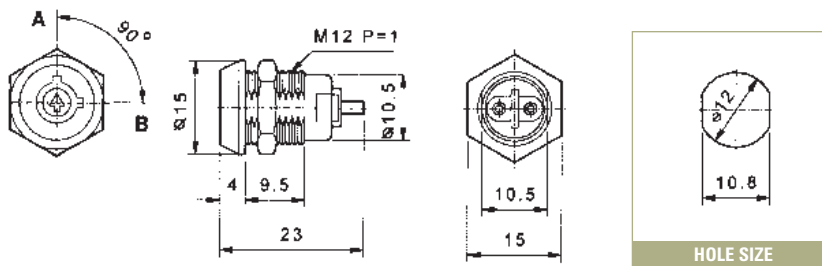

### FEATURES & BENEFITS

- ▶ Zinc alloy die cast housing and cylinder, chrome plated
- ▶ Zinc alloy keys, chrome plated
- ▶ Silver plated contacts and terminals
- ▶ 1 combination available

### SPECIFICATIONS

Ratings:	1A @ 125 VAC
	0.5A @ 250 VAC
Contact Resistance:	20 mΩ max. initial @ 2-4 VDC, 100 mA
Insulation Resistance:	200 MΩ min.
Dielectric Strength:	1,500 V rms @ sea level

Part Number	Lock Configuration (as viewed from key end)	Connected Terminals				Key Pull Possible
		Pos. 1	Pos. 2	Pos. 3	Pos. 4	
KO131A	90° indexing	OFF	1-2			Pos. 1, Pos. 2

• = Detent Position    ◯ = Keypull Possible    ▼ = Momentary

## KO 132

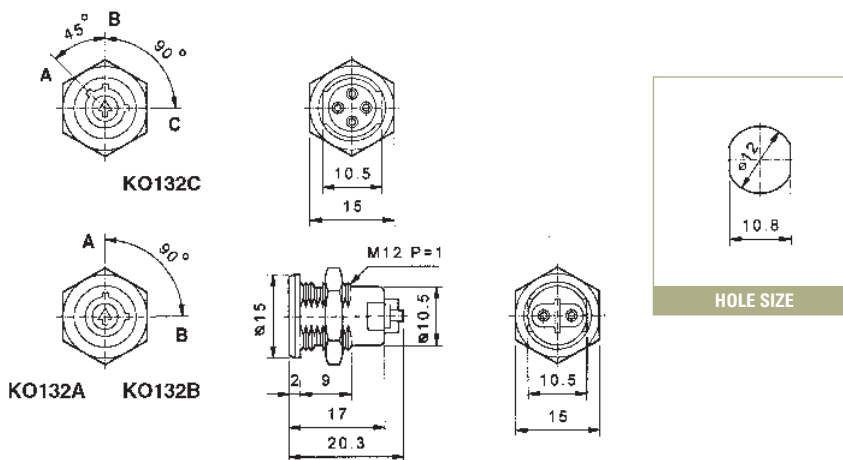

### FEATURES & BENEFITS

- ▶ Zinc alloy die cast housing and cylinder, chrome plated
- ▶ Zinc alloy keys, chrome plated
- ▶ Silver plated contacts and terminals
- ▶ 6 combination available

### SPECIFICATIONS

Ratings:	1A @ 125 VAC
	0.5A @ 250 VAC
Contact Resistance:	20 mΩ max. initial @ 2-4 VDC, 100 mA
Insulation Resistance:	200 MΩ min.
Dielectric Strength:	1,500 V rms @ sea level

Part Number	Lock Configuration (as viewed from key end)	Connected Terminals				Key Pull Possible
		Pos. 1	Pos. 2	Pos. 3	Pos. 4	
KO132A	90° indexing		OFF	1-2		Pos. 1, Pos. 2
KO132B	90° indexing			1-2	3-4	Pos. 1, Pos. 2
KO132C	45°-90° indexing	OFF	1-2		3-4	Pos. 1, Pos. 2, Pos. 3

• = Detent Position    ◯ = Keypull Possible    ▼ = Momentary

# SERIES KO SWITCHES

## KEYLOCK SWITCHES

### KO 133

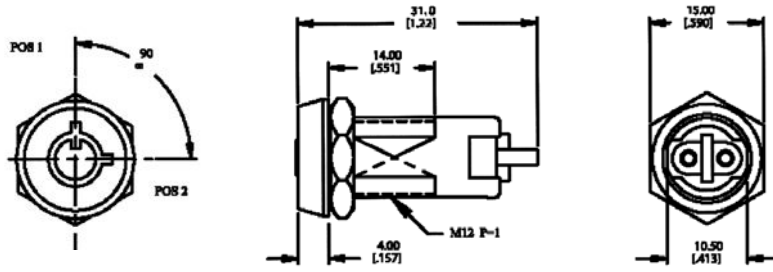

SHOWN: KO133A

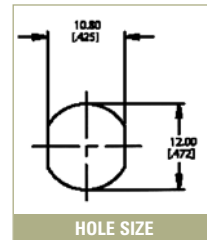

HOLE SIZE

#### FEATURES & BENEFITS

- ▶ Zinc alloy die cast housing and cylinder, chrome plated
- ▶ Zinc alloy keys, chrome plated with plastic cover
- ▶ Silver plated contacts and terminals
- ▶ 4 pins tumbler mechanism
- ▶ 200 combinations available

#### SPECIFICATIONS

Ratings:	1A @ 125 VAC
	0.5A @ 250 VAC
Contact Resistance:	20 mΩ max. initial @ 2-4 VDC, 100 mA
Insulation Resistance:	200 MΩ min.
Dielectric Strength:	1,500 V rms @ sea level

Part Number	Lock Configuration (as viewed from key end)	Connected Terminals				Key Pull Possible
		Pos. 1	Pos. 2	Pos. 3	Pos. 4	
KO133A	90° indexing	OFF	1-2			Pos. 1
KO133B	90° indexing	OFF	1-2			Pos. 1, Pos. 2
KO133C	90° indexing	OFF	1-2			Pos. 1

• = Detent Position    ◯ = Keypull Possible    ▼ = Momentary

TACT SWITCHES

NAVIGATION SWITCHES

PUSHBUTTON SWITCHES

TOGGLE SWITCHES

ROCKER SWITCHES

SLIDE SWITCHES

SNAP-ACTION SWITCHES

DIP SWITCHES

KEYLOCK SWITCHES

ROTARY SWITCHES

DETECTOR SWITCHES

CAP OPTIONS



# SERIES KO SWITCHES

## KEYLOCK COVERS

### KOM

1 DIE CAST ZINC

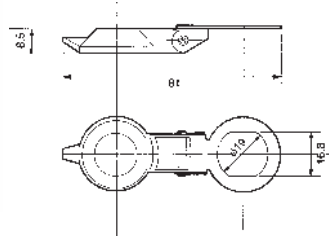

3 DIE CAST ZINC

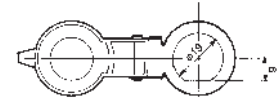

2 DIE CAST ZINC

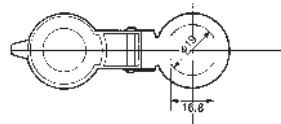

4 DIE CAST ZINC

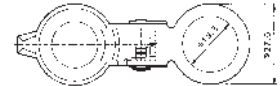

### KOC

1 RUBBER

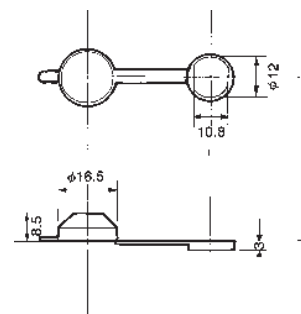

3 RUBBER

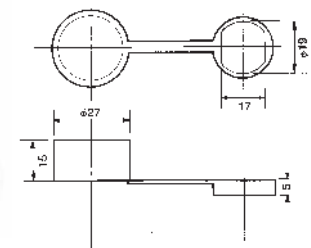

2 PLASTIC

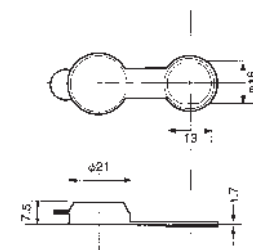

Model No.	Used for:
KOC1	KO 103, KO 131, KO 132
KOC2	KO 104
KOC3	KO 113, KO 114, KO 119, KO 120
KOM1-4	KO 113, KO 114

TACT SWITCHES

NAVIGATION SWITCHES

PUSHBUTTON SWITCHES

TOGGLE SWITCHES

ROCKER SWITCHES

SLIDE SWITCHES

SNAP-ACTION SWITCHES

DIP SWITCHES

KEYLOCK SWITCHES

ROTARY SWITCHES

DETECTOR SWITCHES

CAP OPTIONS